

STEINBERG

PURE RELAXATION
WITH SENSUAL RAIN
SHOWERS

PUSHTRONIC
& **iFlow**

MODERN,
INTUITIVE
AND DIGITAL

BATHWORLD

201 Henderson Road #03-15,
APEX@Henderson, Singapore 159545
T: +65 6352 2202 E: sales@bathworld.net



new



“

Erleben Sie das Gefühl einer entspannenden Dusche am Morgen, die sich über einen einfachen Knopfdruck bedienen lässt. Mit den Push-Armaturen von Steinberg haben Sie es in der Hand. Edel, einfach und hochmodern: Spüren Sie den Luxus per Knopfdruck in Ihrem Badezimmer.

Experience the magic of a relaxing morning shower caressing your skin by just pushing a button. With the Steinberg push mixer tap it's up to you. Exquisite, easy to use and state of the art: Feel the luxury in your bathroom at the touch of a button.

”

PUSH
ELECTRONIC

new

PUSHTRONIC

390 2221



390 2321



390 2231



390 2331



2

VERBRAUCHER
OUTLETS

3

VERBRAUCHER
OUTLETS



4 Buttons im Lieferumfang enthalten / 4 buttons included



PUSH
TRONIC

UNTERPUTZ-EINHEBELMISCHER
MIT PUSHTRONIC BEDIENKOMFORT

CONCEALED SINGLE LEVER
WITH PUSHTRONIC USER COMFORT

new



UNTERPUTZ-THERMOSTAT
MIT PUSHTRONIC BEDIENKOMFORT

CONCEALED THERMOSTATIC MIXER
WITH PUSHTRONIC USER COMFORT

PUSHTRONIC

390 4221



390 4321



390 4231



390 4331



2

VERBRAUCHER
OUTLETS

3

VERBRAUCHER
OUTLETS



4 Buttons im Lieferumfang enthalten / 4 buttons included

new



PUSH
TRONIC



Das Thermostat lässt sich durch eine Drehbewegung einstellen, die Brausen über einen Knopfdruck einschalten und außerdem können Sie verschiedene Verbraucher zeitgleich verwenden. Die einfache und intuitive Handhabung macht den hohen Bedienkomfort der Push-Armatur aus.

Set the thermostat by rotating the dial, turn the water on by pushing the button, and even direct it to several outlets at once. Its easy and intuitive use is what makes the push mixer tap so comfortable.



44 mm

new

390 2232



390 4232



3
VERBRAUCHER
OUTLETS

390 2242



390 4242



4
VERBRAUCHER
OUTLETS



4 Buttons im Lieferumfang enthalten / 4 buttons included



UNTERPUTZ-THERMOSTAT
MIT PUSHTRONIC BEDIENKOMFORT

CONCEALED THERMOSTATIC MIXER
WITH PUSHTRONIC USER COMFORT





SENSUAL RAIN



THE LUXURY OF YOUR PERSONAL HOME-SPA

Warum in die Ferne schweifen, wenn sich ein erstklassiges Spa-Erlebnis jeden Tag zu Hause genießen lässt? Beginnen Sie Ihren perfekten Tag unter der Dusche mit Armaturen der Serie Sensual Rain von Steinberg: Das moderne, elegante Design passt sich jedem Badambiente an und lässt sich serienübergreifend miteinander kombinieren. Für Dusch-Highlights sorgen entspannende Regenduschen und -paneele sowie der Bedienkomfort smarterer Funktionen wie iFlow und Pushtronic.

Why travel far afield while a first-class spa experience is waiting for you at home, every day? Start your perfect day in the shower – with Sensual Rain mixers, shower heads and shower panels from Steinberg: The modern, elegant design blends into any bathroom interior and matches mixers and accessories also from other Steinberg series. Make your ultimate shower experience under our relaxing rain shower heads and panels with smart comfort features like iFlow and Pushtronic.



















ENJOY THE SHOWER EXPERIENCE



Alle Steinberg Oberflächen zeichnen sich durch hohe Qualität und Langlebigkeit aus. Und auch die Pflege ist unkompliziert: mit einem sanften, neutralen Mittel reinigen und anschließend trockenreiben. Unsere Kopfbrausen sind mit **Easy Clean** Funktion ausgestattet: dafür einfach nur regelmäßig mit den Fingern über die Düsen streichen – das verhindert Kalkablagerungen.

All Steinberg finishes are of high quality and durability. Also cleaning is easy: Rinse with a soft, neutral cleaner and wipe dry. Our overhead shower heads feature **Easy Clean**: Simply wipe your fingers across the nozzles from time to time to avoid calcification.

AUSFÜHRUNGEN / VERSIONS

100 1687					
200 mm	CHROME	MATT BLACK	ROSE GOLD	GUN METAL	
100 1686					
250 mm	CHROME	MATT BLACK	BRUSHED NICKEL		
100 1688					
300 mm	CHROME	MATT BLACK	ROSE GOLD		
100 1689					
400 mm	CHROME				





PUSHTRONIC
390 2221

Colours:



CHROME



MATT
BLACK



390 4231
Unterputz-Thermostat
Concealed thermostatic mixer



COMFORT PAIRED WITH INDIVIDUALITY







Gönnen Sie sich eine Luxusdusche mit allen Annehmlichkeiten: Mit der intuitiv zu bedienenden Armatur Pushtronic lässt sich der persönliche Duschmoment ganz individuell selbst gestalten. So wird die tägliche Duschroutine zum absoluten Lieblingsritual.

Treat yourself – have a luxury shower with all comforts: Design your very own individual shower moment completely as you like with the intuitive Pushtronic mixer control. Make the daily shower routine your favourite ritual.

120 1686 Regenbrause | Rain shower head



AUSFÜHRUNGEN / VERSIONS

120 1686			
	300 x 300 mm	CHROME	MATT BLACK
120 1687	120 1688	120 1689	
			CHROME
145 x 220 mm	200 x 300 mm	400 x 400 mm	

RELAXING RAIN SHOWER MOMENTS

Einfach mal den Alltag draußen lassen und sich ganz dem Moment hingeben – eine Dusche unter der Regenbrause schenkt Ihnen Tag für Tag eine entspannte Auszeit. Bei Steinberg können Sie zwischen verschiedenen Designs und Größen wählen. Mit dem entsprechenden Brausearm ist sowohl eine Wand- als auch Deckenmontage möglich.

Wash off the daily grind and indulge in the magic moment – a rain shower will give you a relaxing break, day after day. You may choose from a variety of dimensions and Steinberg designs. A matching shower arm allows both wall and ceiling mounting.





390 5652
Wall Rain Regenpaneel
Wall Rain shower panel

390 2221
Unterputz-Einhebelmischer
Concealed single lever

WELCOME TO YOUR SPA OASIS

Willkommen zur Wellness-Behandlung: Nach einem vollen und großflächigen Regenguss verwöhnt Sie ein kräftiger, massierender Wasserschwall – oder mögen Sie es sanfter? Die Regenduschen überzeugen mit verschiedenen Strahlarten, zeitlosem Design und viel Komfort. An die Wand montiert fügen sie sich in fast jedes Badezimmer ein.

Welcome to your spa treatment: After a full, wide rain cascade please your skin with a powerful massaging jet – or do you like it softer? Our rain shower heads and panels come with various spray modes, timeless design and many comfort features. Wall mounted they blend into almost every bathroom interior.





390 6412
Regenpaneel
Rain shower panel

AUSFÜHRUNGEN / VERSIONS



POLISHED STAINLESS STEEL BRUSHED STAINLESS STEEL MATT BLACK

REFRESH OR RELAX?

Wie sieht Ihr Morgenritual aus? Bei unseren Regenpaneelen entscheiden Sie, nach welcher Dusche Sie sich gerade fühlen. Für ein abwechslungsreiches Duscherlebnis können Sie aus bis zu drei Strahlarten wählen: den vollen und großflächigen Regenguss, einen sanft-umhüllenden Duschregen sowie einen kräftig massierenden Wasserstrahl.

What is your morning ritual like? With our rain panels it's you who decides which shower mode answers your mood. You may choose between up to three spray modes for the perfect shower experience to match the moment: the intense wide shower jet; the soothing, enveloping shower rain; and the strong, massaging blade jet.

390 6620
Regenpaneel mit LED
Rain shower panel with LED lights

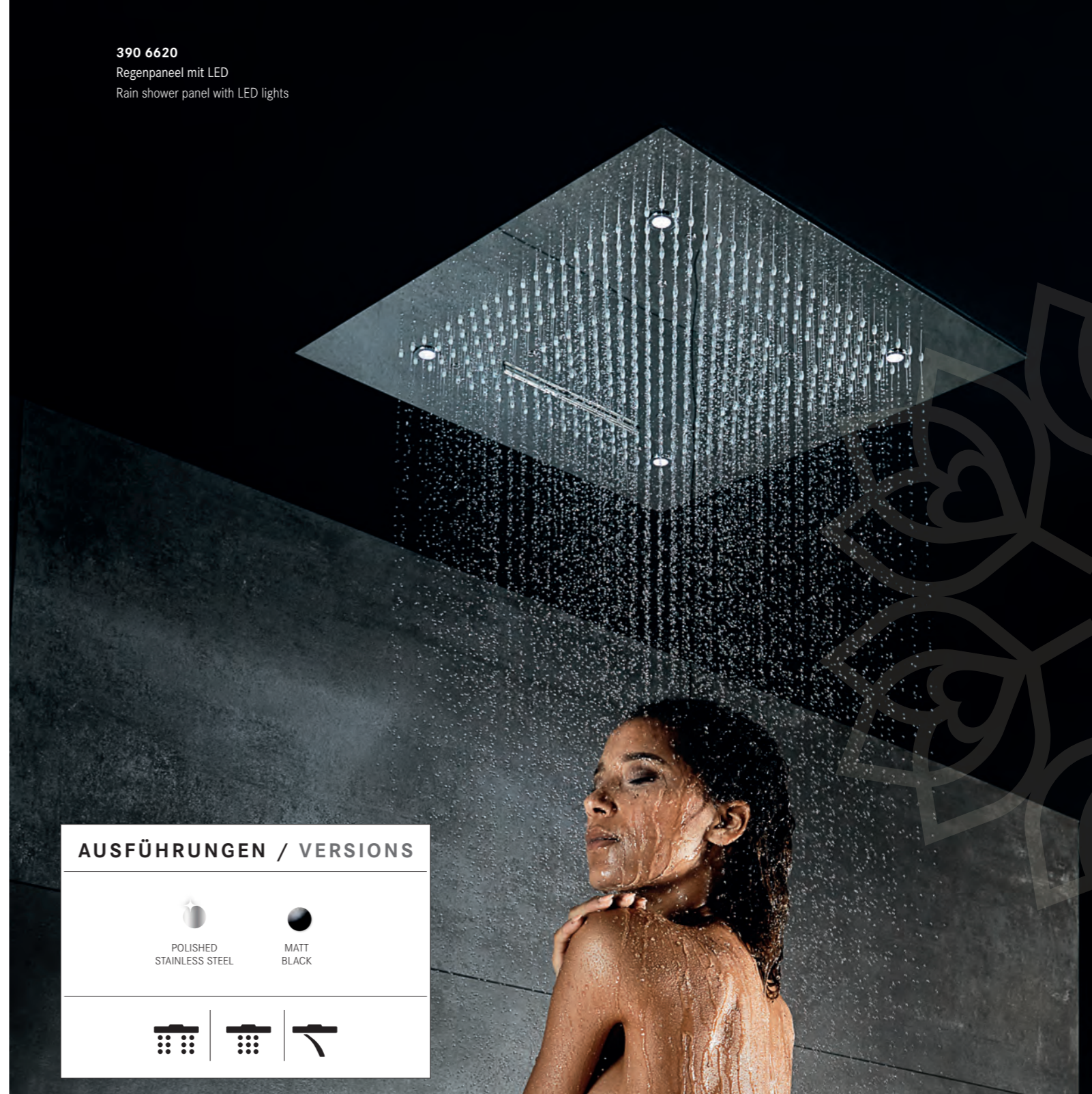

AUSFÜHRUNGEN / VERSIONS



POLISHED STAINLESS STEEL MATT BLACK



SPOT ON FOR YOUR SENSUAL HIGHLIGHT

Lassen Sie sich beim Duschen nicht nur von einem weichen Wasserstrahl berieseln, sondern auch von sanften Lichtstrahlen – das ist Luxus und Entspannung pur für alle Sinne. Damit Ihre Regendusche im schönsten Licht erstrahlt, finden Sie bei uns Regenpaneelen mit bis zu 13 LED-Spots.

Don't leave it just to the soothing shower rain to please you – let soft rays of light join in to do the same. It's pure luxury and relaxation to your senses. To bath your rain shower in the most beautiful light we have LED lighted rain panels on offer – with up to 13 LED spots.



UNTERPUTZ-THERMOSTAT ¾"

mit pushtronic Bedienkomfort, komplett mit Unterputzkörper,
4 Buttons mit unterschiedlichen Symbolen im Lieferumfang enthalten,
mit Abdeckplatte 145 mm x 200 mm, chrom

CONCEALED THERMOSTATIC MIXER ¾"

with pushtronic user comfort, complete with concealed unit,
4 buttons with different symbols included, with cover plate 145 mm x 200 mm chrome

MÉLANGEUR THERMOSTATIQUE ¾"

avec pushtronic sélection, complet avec corps d'encastrement, Bouton-poussoir marche/arrêt,
utilisation simultanée de plusieurs sorties, 4 boutons avec diff. symboles de fonctions inclus,
avec plaque de protection 145 mm x 200 mm, chromé

TERMOSTAT PODTYNKOWY ¾"

z komfortową obsługą pushtronic, w komplecie z elementem podtynkowym,
4 przyciski z różnymi symbolami w dostarczanym zestawie, z rozetą 145 mm x 200 mm, chrom



UNTERPUTZ-EINHEBELMISCHER ¾"

mit pushtronic Bedienkomfort, komplett mit Unterputzkörper,
4 Buttons mit unterschiedlichen Symbolen im Lieferumfang enthalten,
mit Abdeckplatte 145 mm x 200 mm, chrom

CONCEALED SINGLE LEVER ¾"

with pushtronic user comfort, complete with concealed unit,
4 buttons with different symbols included, with cover plate 145 mm x 200 mm chrome

MITIGEUR MONO COMMANDE ¾"

avec pushtronic sélection, complet avec corps d'encastrement, Bouton-poussoir marche/arrêt,
utilisation simultanée de plusieurs sorties, 4 boutons avec diff. symboles de fonctions inclus,
avec plaque de protection 145 mm x 200 mm, chromé

BATERIA PODTYNKOWA Z MIESZACZEM ¾"

z komfortową obsługą pushtronic, w komplecie z elementem podtynkowym,
4 przyciski z różnymi symbolami w dostarczanym zestawie, z rozetą 145 mm x 200 mm, chrom



390 4221

für 2 Verbraucher
ohne Mengenregulierung

for 2 outlets,
without volume control

pour 2 utilisateurs,
sans réglage de débit

2 wyjścia,
bez regulacji ciśnienia

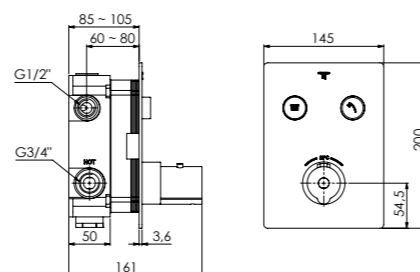

3 bar



20 l/min



20 l/min



390 2221

für 2 Verbraucher,
mit Mengenregulierung

for 2 outlets,
with volume control,

pour 2 utilisateurs,
avec réglage du débit

2 wyjścia,
z regulacją ciśnienia

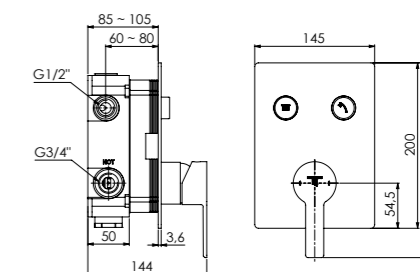

3 bar



22 l/min



22 l/min



390 4231

für 3 Verbraucher,
ohne Mengenregulierung

for 3 outlets,
without volume control

pour 3 utilisateurs,
sans réglage de débit

3 wyjścia,
bez regulacji ciśnienia

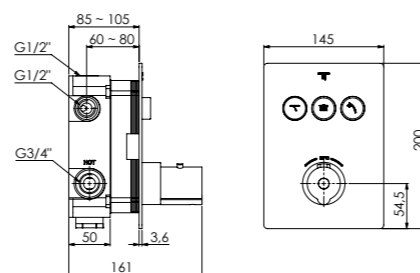

3 bar



20 l/min



20 l/min



20 l/min



390 2231

für 3 Verbraucher,
mit Mengenregulierung

for 3 outlets,
with volume control

pour 3 utilisateurs,
avec réglage du débit

3 wyjścia,
z regulacją ciśnienia

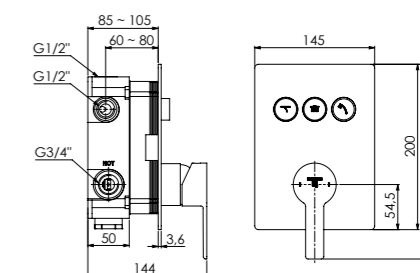

3 bar



22 l/min



22 l/min



22 l/min



UNTERPUTZ-THERMOSTAT ¾"

mit pushtronic Bedienkomfort, komplett mit Unterputzkörper,
4 Buttons mit unterschiedlichen Symbolen im Lieferumfang enthalten,
mit Abdeckplatte Ø200 mm, chrom

CONCEALED THERMOSTATIC MIXER ¾"

with pushtronic user comfort, complete with concealed unit,
4 buttons with different symbols included, with cover plate dia. 200 mm, chrome

MÉLANGEUR THERMOSTATIQUE ¾"

avec pushtronic sélection, complet avec corps d'encastrement, Bouton-poussoir marche/arrêt,
utilisation simultanée de plusieurs sorties, 4 boutons avec diff. symboles de fonctions inclus,
avec plaque de protection Ø200 mm, chromé

TERMOSTAT PODTYNKOWY ¾"

z komfortową obsługą pushtronic, w komplecie z elementem podtynkowym,
4 przyciski z różnymi symbolami w dostarczanym zestawie, z rozetą Ø200 mm, chrom



390 4321

für 2 Verbraucher,
ohne Mengenregulierung
for 2 outlets,
without volume control
pour 2 utilisateurs,
sans réglage de débit
2 wyjścia,
bez regulacji ciśnienia

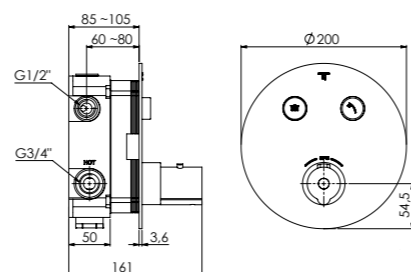

3 bar



20 l/min



20 l/min



UNTERPUTZ-EINHEBELMISCHER ¾"

mit pushtronic Bedienkomfort, komplett mit Unterputzkörper,
4 Buttons mit unterschiedlichen Symbolen im Lieferumfang enthalten,
mit Abdeckplatte 145 mm x 200 mm, chrom

CONCEALED SINGLE LEVER ¾"

with pushtronic user comfort, complete with concealed unit,
4 buttons with different symbols included, with cover plate 145 mm x 200 mm, chrome

MITIGEUR MONO COMMANDE ¾"

avec pushtronic sélection, complet avec corps d'encastrement, Bouton-poussoir marche/arrêt,
utilisation simultanée de plusieurs sorties, 4 boutons avec diff. symboles de fonctions inclus,
avec plaque de protection 145 mm x 200 mm, chromé

BATERIA PODTYNKOWA Z MIESZACZEM ¾"

z komfortową obsługą pushtronic, w komplecie z elementem podtynkowym,
4 przyciski z różnymi symbolami w dostarczanym zestawie, z rozetą 145 mm x 200 mm, chrom



390 2321

für 2 Verbraucher,
mit Mengenregulierung
for 2 outlets,
with volume control,
pour 2 utilisateurs,
avec réglage du débit
2 wyjścia,
z regulacją ciśnienia

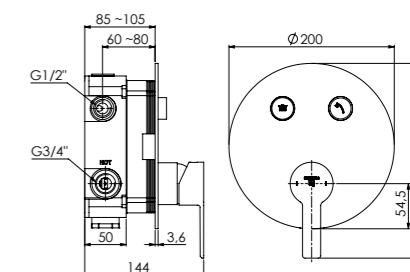

3 bar



22 l/min



22 l/min



390 4331

für 3 Verbraucher,
ohne Mengenregulierung
for 3 outlets,
without volume control
pour 3 utilisateurs,
sans réglage de débit
3 wyjścia,
bez regulacji ciśnienia

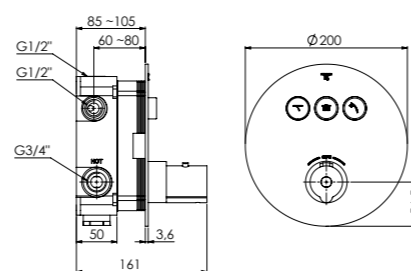

3 bar



20 l/min



20 l/min



20 l/min



390 2331

für 3 Verbraucher,
mit Mengenregulierung
for 3 outlets,
with volume control
pour 3 utilisateurs,
avec réglage du débit
3 wyjścia,
z regulacją ciśnienia

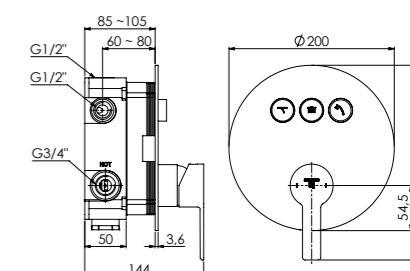

3 bar



22 l/min



22 l/min



22 l/min



UNTERPUTZ-THERMOSTAT 3/4"

mit pushtronic Bedienkomfort, komplett mit Unterputzkörper, mit integriertem Schlauchanschluss und Brausehalter sowie einer Metall-Stabhandbrause und Brauseschlauch, 4 Buttons mit unterschiedlichen Symbolen im Lieferumfang enthalten, mit Abdeckplatte 120 mm x 396 mm, chrom

CONCEALED THERMOSTATIC MIXER 3/4"

with pushtronic user comfort, complete with concealed unit, with integrated shower bracket and porter, including Metal hand shower and shower hose, 4 buttons with different symbols included, with cover plate 120 mm x 396 mm, chrome

MÉLANGEUR THERMOSTATIQUE 3/4"

avec pustronic sélection, complet avec corps d'encastrement, Bouton-poussoir marche/arrêt pour 3 sorties, utilisation simultanée de plusieurs sorties, avec douchette à main et coude/support, 4 boutons avec diff. symboles de fonctions inclus, avec plaque de protection 120 mm x 396 mm, chromé

TERMOSTAT PODTYNKOWY 3/4"

z komfortową obsługą pushtronic, w komplecie z elementem podtynkowym, ze zintegrowanym przyłączem węża i uchwytem słuchawki jak również słuchawką metalową i wężem, 4 przyciski z różnymi symbolami w dostarczanym zestawie, z rozetą 120 mm x 396 mm, chrom



390 4232

für 3 Verbraucher,
ohne Mengenregulierung

for 3 outlets,
without volume control
pour 3 utilisateurs,
sans réglage de débit

3 wyjścia,
bez regulacji ciśnienia

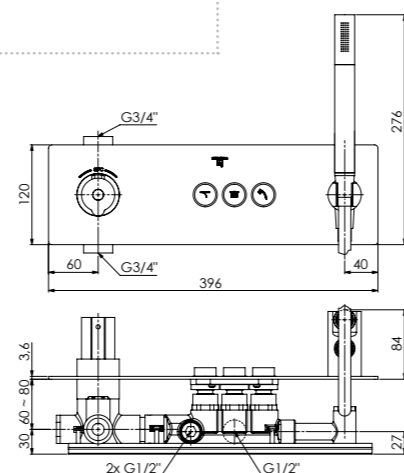

3 bar



20 l/min

20 l/min

6 l/min



390 4242

für 4 Verbraucher,
ohne Mengenregulierung

for 4 outlets,
without volume control
pour 4 utilisateurs,
sans réglage de débit

4 wyjścia,
bez regulacji ciśnienia

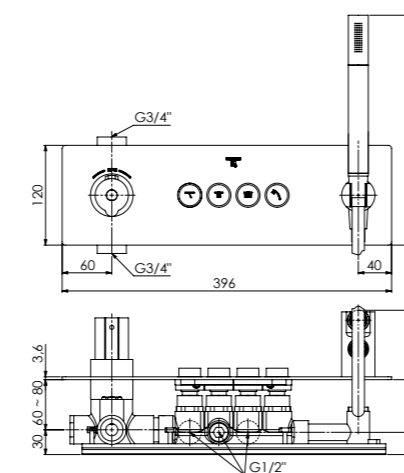

3 bar



20 l/min

20 l/min

20 l/min

6 l/min



UNTERPUTZ-EINHEBELMISCHER 3/4"

mit pushtronic Bedienkomfort, komplett mit Unterputzkörper, mit integriertem Schlauchanschluss und Brausehalter sowie einer Metall-Stabhandbrause und Brauseschlauch, 4 Buttons mit unterschiedlichen Symbolen im Lieferumfang enthalten, mit Abdeckplatte 120 mm x 396 mm, chrom

CONCEALED SINGLE LEVER 3/4"

with pushtronic user comfort, complete with concealed unit, with integrated shower bracket and porter, including Metal hand shower and shower hose, 4 buttons with different symbols included, with cover plate 120 mm x 396 mm, chrome

MITIGEUR MONO COMMANDE 3/4"

avec pustronic sélection, complet avec corps d'encastrement, Bouton-poussoir marche/arrêt pour 3 sorties, utilisation simultanée de plusieurs sorties, avec douchette à main et coude/support, 4 boutons avec diff. symboles de fonctions inclus, avec plaque de protection 120 mm x 396 mm, chromé

BATERIA PODTYNKOWA Z MIESZACZEM 3/4"

z komfortową obsługą pushtronic, w komplecie z elementem podtynkowym, ze zintegrowanym przyłączem węża i uchwytem słuchawki jak również słuchawką metalową i wężem, 4 przyciski z różnymi symbolami w dostarczanym zestawie, z rozetą 120 mm x 396 mm, chrom



390 2232

für 3 Verbraucher,
mit Mengenregulierung

for 3 outlets,
with volume control
pour 3 utilisateurs,
avec réglage du débit

3 wyjścia,
z regulacją ciśnienia

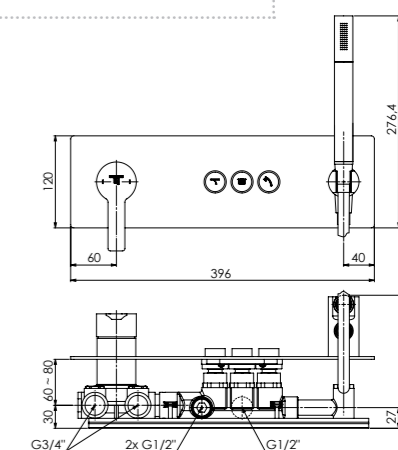

3 bar



26 l/min

26 l/min

6 l/min



390 2242

für 4 Verbraucher,
mit Mengenregulierung

for 4 outlets,
with volume control
pour 4 utilisateurs,
avec réglage du débit

4 wyjścia,
z regulacją ciśnienia

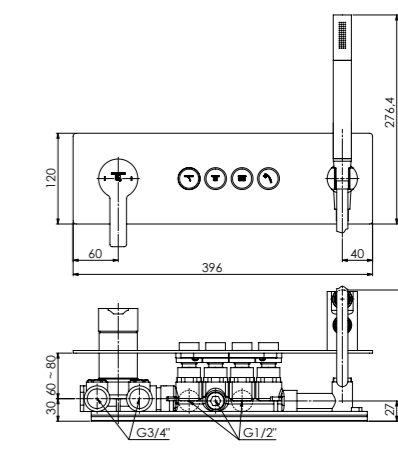

3 bar



26 l/min

26 l/min

26 l/min

6 l/min

FERTIGMONTAGESET

für Unterputzthermostat mit 2-Wege-Umsteller
(Einbaukörper 010 4140, 010 4140 S separat bestellen, Seite 197)

FINISH SET

for concealed thermostatic mixer with 2 way diverter
(Concealed set 010 4140, 010 4140 S order separately, page 197)

JEU DE FINITION

pour mélangeur thermostatique avec inverseur a 2 voies intégrées, 2 x sorties,
corps d'encastrement (010 4140, 010 4140 S à commander séparément, page 197)

ELEMENT ZEWNĘTRZNY

do termostatu podtynkowego z dwudrożnym przełącznikiem,
(element podtynkowy 010 4140, 010 4140 S zamawiać oddzielnie, strona 197)



Ø 12,5 l/min
3 bar

100 4133 1

mit Abdeckplatt e Ø190 mm, chrom
with cover plate dia. 190 mm, chrome
avec plaque de protection Ø190 mm, chromé
z rozetą Ø190 mm, chrom

new ● Matt Black 100 4133 1 S

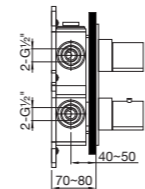
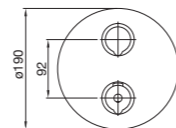

Ø 12,5 l/min
3 bar

230 4133

mit Abdeckplatt e 220 mm x 150 mm, chrom
with cover plate 220 mm x 150 mm, chrome
avec plaque de protection 220 mm x 150 mm, chromé
z rozetą 220 mm x 150 mm, chrom

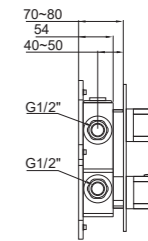
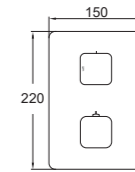

Ø 12,5 l/min
3 bar

250 4133

mit Abdeckplatt e Ø190 mm, chrom
with cover plate dia. 190 mm, chrome
avec plaque de protection Ø190 mm, chromé
z rozetą Ø190 mm, chrom

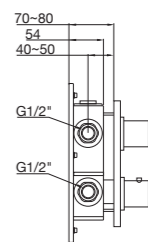
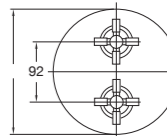

UNTERPUTZ EINBAUKÖRPER ½"

Universell für alle Unterputzthermostate mit 2-Wege-Umsteller,
Temperatur- und Mengenregulierung

CONCEALED SET ½"

for thermostatic shower mixer with 2 way diverter, temperature and volume control

CORPS D'ENCASTREMENT ½"

pour mélangeur avec inverseur 2 voies, avec réglage de débit

ELEMENT PODTYNKOWY PODŁĄCZENIA ½"

do termostatu podtynkowego, z dwudrożnym przełącznikiem, regulacją temperatury



Ø 12,5 l/min
3 bar

120 4133 1

mit Abdeckplatt e 200 mm x 145 mm, chrom
with cover plate 200 mm x 145 mm, chrome
avec plaque de protection 200 mm x 145 mm, chromé
z rozetą 200 mm x 145 mm, chrom

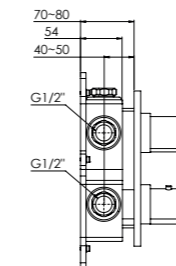
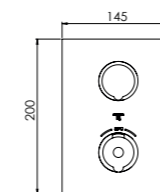

Ø 12,5 l/min
3 bar

160 4133

mit Abdeckplatt e 220 mm x 150 mm, chrom
with cover plate 220 mm x 150 mm, chrome
avec plaque de protection 220 mm x 150 mm, chromé
z rozetą 220 mm x 150 mm, chrom

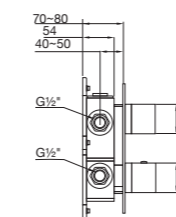
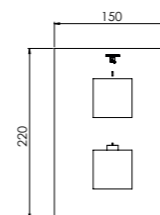

010 4140

mit wasserdichtem Einbaukasten,
mit Kerdi Dichtmanschett e, mit Schallschutzmatt e,
eigensicher gegen Rückfließen, chrom

with water-tight concealed box, with waterproof kerdi
membrane, with noise absorbing mat, intrinsically safe
against backflow, chrome

avec boîte étanche, avec membrane d'eau "Kerdi", avec
tapis insonorisant, sécurité contre le reflux, chromé

z wodoszczelną obudową, z wodoszczelną membraną Kerdi,
z zabezpieczeniem przepływów zwrotnych, chrom

new ● Matt Black 010 4140 S

Montagevideo
installation video
vidéo d'installation
film montażowy



REGENBRAUSEN
RAIN SHOWERS
DOUCHE DE TÊTE
DESZCZOWNICE



SENSUAL RAIN REGENPANEEL

für Deckeneinbau komplett mit Einbaurahmen, mit Easy Clean, Edelstahl poliert, Schutzklasse IP44, Netzteil 12 Volt, Nennstrom ≤ 30 mA

SENSUAL RAIN SHOWER PANEL

ceiling mounted with mounting frame, with Easy Clean, polished stainless steel, protection level IP44, power supply 12 Volt, current ≤ 30mA

SENSUAL RAIN CIEL DE PLUIE AVEC LED

pour montage encastré, avec cadre d'installation, avec système anticalcaire „Easy Clean“, inox poli, classe protection IP 44, alimentation 12 V, courant nominal < 30mA

DESZCZOWNICA SENSUAL RAIN Z DIODAMI LED

do montażu sufitowego w komplecie z ramą montażową, z systemem Easy Clean, stal szlachetna polerowana, Stopień ochrony IP44, Zasilacz 12 Volt, prąd znamionowy ≤ 30 mA

390 6032

1220 mm x 620 mm

3 Strahlarten, mit Beleuchtung: 13 LED Lampen (weiß)

3 fonctions, with lighting: 13 LEDs (white)

3 fonctions, éclairage 13 LED (blanc)

3 typy strumienia, oświetlenie: 13 diod LED, białe



16,2 20,8 21,5

l/min – 3 bar

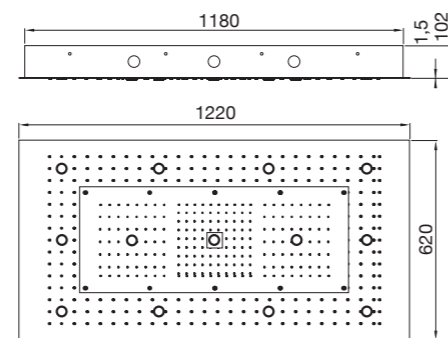

SENSUAL RAIN REGENPANEEL

für Deckeneinbau komplett mit Einbaurahmen, mit Easy Clean, Edelstahl poliert

SENSUAL RAIN SHOWER PANEL

ceiling mounted with mounting frame, with Easy Clean, polished stainless steel

SENSUAL RAIN CIEL DE PLUIE

pour montage encastré, avec cadre d'installation, avec système anticalcaire „Easy Clean“, inox poli

DESZCZOWNICA SENSUAL RAIN

do montażu sufitowego w komplecie z ramą montażową, z systemem Easy Clean, stal szlachetna polerowana

390 6031

1220 mm x 620 mm

3 Strahlarten

3 fonctions

3 fonctions

3 typy strumienia



16,2 20,8 21,5

l/min – 3 bar

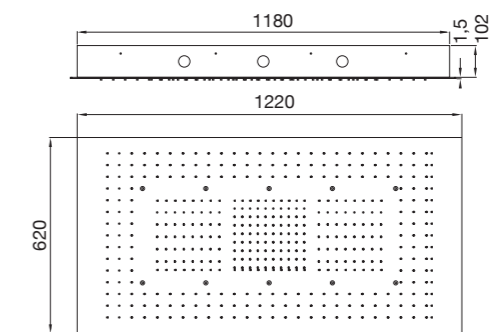
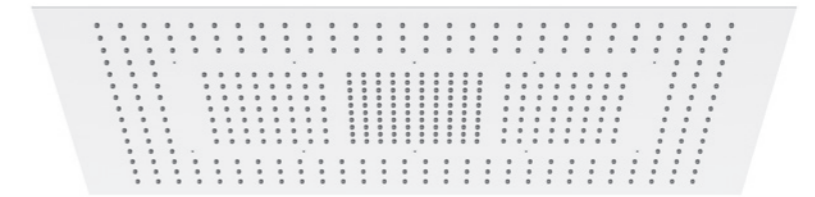

390 6832

600 mm x 800 mm

3 Strahlarten, mit Beleuchtung: 4 LED Lampen (weiß)

3 fonctions, with lighting: 4 LEDs (white)

3 fonctions, éclairage 4 LED (blanc)

3 typy strumienia, oświetlenie: 4 diod LED (białe)

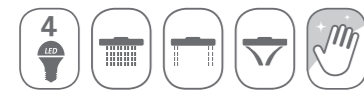

19,2 23,5 22,8

l/min – 3 bar

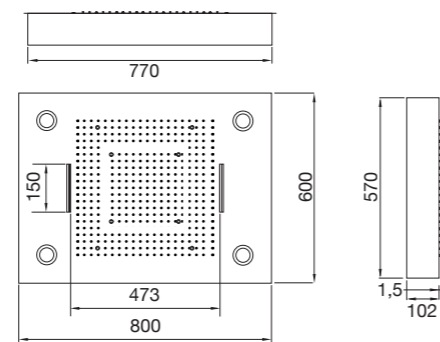
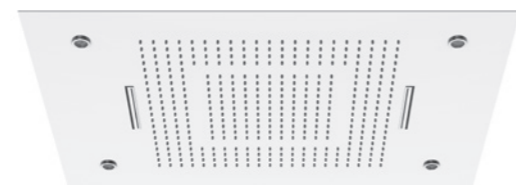

390 6831

600 mm x 800 mm

3 Strahlarten

3 fonctions

3 fonctions

3 typy strumienia



19,2 23,5 22,8

l/min – 3 bar

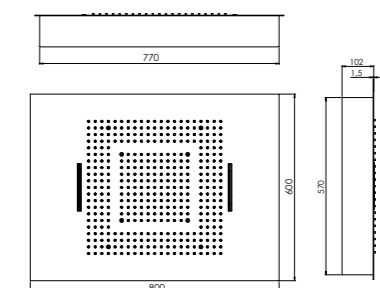
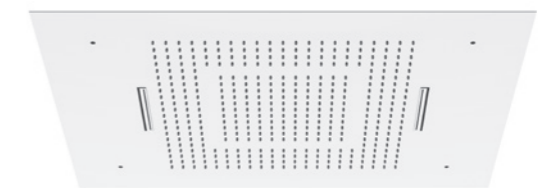

SENSUAL RAIN REGENPANEEL

für Deckeneinbau komplett mit Einbaurahmen, mit Easy Clean, Edelstahl poliert, Schutzklasse IP44, Netzteil 12 Volt, Nennstrom ≤ 30 mA

SENSUAL RAIN SHOWER PANEL

ceiling mounted, with prime frame, with Easy Clean, polished stainless steel
protection level IP44, power supply 12 Volt, current ≤ 30 mA

SENSUAL RAIN CIEL DE PLUIE AVEC LED

pour montage encastré, avec système anticalcaire „Easy Clean“, éclairage 4 LED, classe protection IP 44, alimentation 12 V, courant nominal < 30 mA inox polis

DESZCZOWNICA SENSUAL RAIN Z DIODAMI LED

do zabudowy sufitowej, z systemem Easy Clean/stal szlachetna chromowana oświetlenie: 4 lampki LED, stopień ochrony IP44, zasilanie 12 Volt, prąd znamionowy ≤ 30 mA

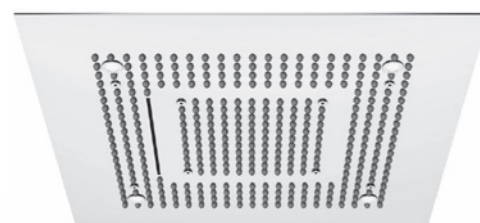

390 6620

600 mm x 600 mm

3 Strahlarten, mit Beleuchtung: 4 LED Lampen (weiß)
3 fonctions, with lighting: 4 LEDs (white)
3 fonctions, éclairage 4 LED (blanc)
3 typy strumienia, oświetlenie: 4 diod LED (białe)



15,5 19,9 24,4

l/min – 3 bar

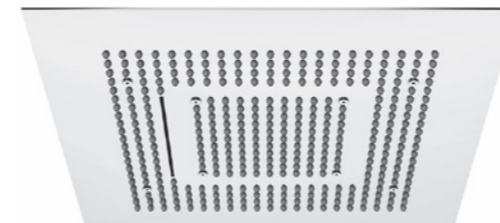
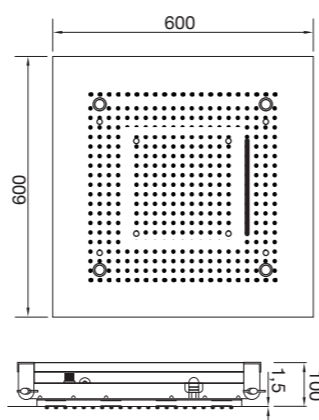

390 6610

600 mm x 600 mm

3 Strahlarten
3 fonctions
3 fonctions
3 typy strumienia



15,5 19,9 24,4

l/min – 3 bar

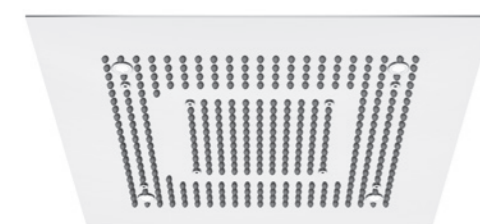
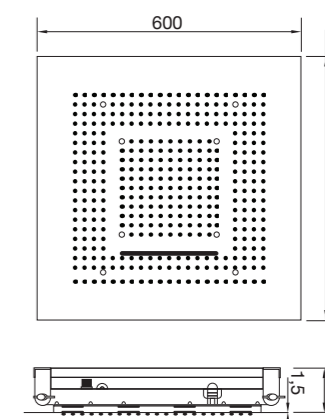

390 6622

600 mm x 600 mm

2 Strahlarten, mit Beleuchtung: 4 LED Lampen (weiß)
2 fonctions, with lighting: 4 LEDs (white)
2 fonctions, éclairage 4 LED (blanc)
2 typy strumienia, oświetlenie: 4 diod LED (białe)



18,6 22,8

l/min – 3 bar

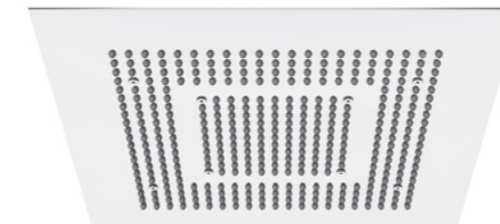
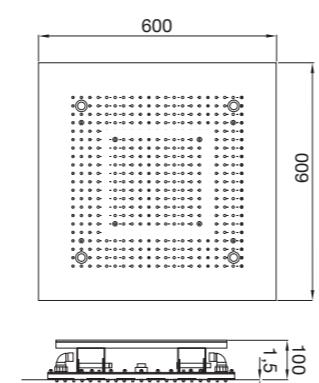

390 6612

600 mm x 600 mm

2 Strahlarten
2 fonctions
2 fonctions
2 typy strumienia



18,6 22,8

l/min – 3 bar

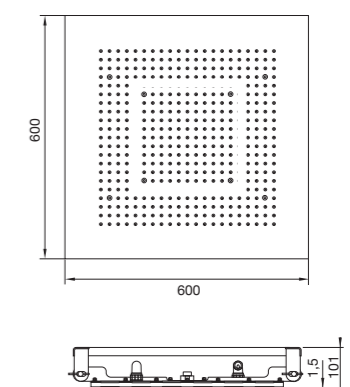

SENSUAL RAIN REGENPANEEL

für Deckeneinbau komplett mit Einbaurahmen, mit Easy Clean, Edelstahl poliert, Schutzklasse IP44, Netzteil 12 Volt, Nennstrom ≤ 30 mA

SENSUAL RAIN SHOWER PANEL

with 3 functions, ceiling mounted, with prime frame, with Easy Clean, polished stainless steel, protection level IP44, power supply 12 Volt, current ≤ 30mA

SENSUAL RAIN CIEL DE PLUIE AVEC LED

pour montage encastré, avec anticalcaire, éclairage 8 LED, classe protection IP 44, alimentation 12 V, courant nominal < 30mA, inox poli

DESZCZOWNICA SENSUAL RAIN Z DIODAMI LED

do zabudowy sufitowej, z systemem Easy Clean/ stal szlachetna chromowana oświetlenie: 8 diod LED, stopień ochrony IP44, zasilanie 12 Volt, prąd znamionowy ≤30mA

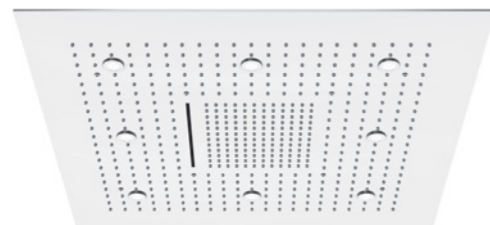

390 6680

800 mm x 800 mm

3 Strahlarten, mit Beleuchtung: 8 LED Lampen (weiß)

3 fonctions, with lighting: 8 LEDs (white)

3 fonctions, éclairage 8 LED (blanc)

3 typy strumienia, oświetlenie: 8 diod LED (białe)

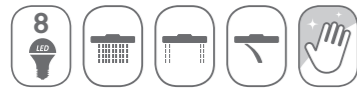

15,5 23,3 24,1

l/min – 3 bar

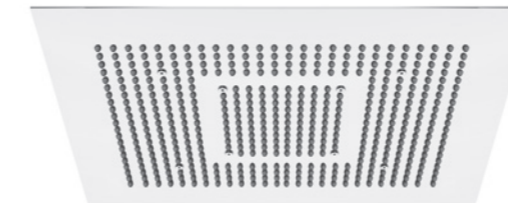
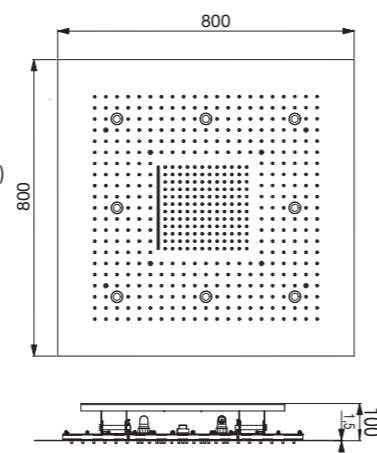

390 6812

800 mm x 600 mm

2 Strahlarten

2 fonctions

2 typy strumienia

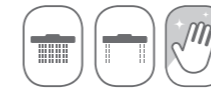

22,1 27,9

l/min – 3 bar

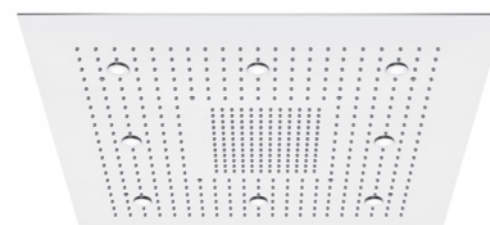
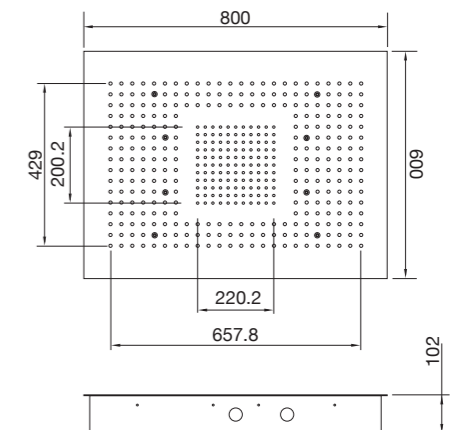

390 6822

800 mm x 800 mm

2 Strahlarten, mit Beleuchtung: 8 LED Lampen (weiß)

2 fonctions, with lighting: 8 LEDs (white)

2 fonctions, éclairage 8 LED (blanc)

2 typy strumienia, oświetlenie: 8 diod LED (białe)



23 22,5

l/min – 3 bar

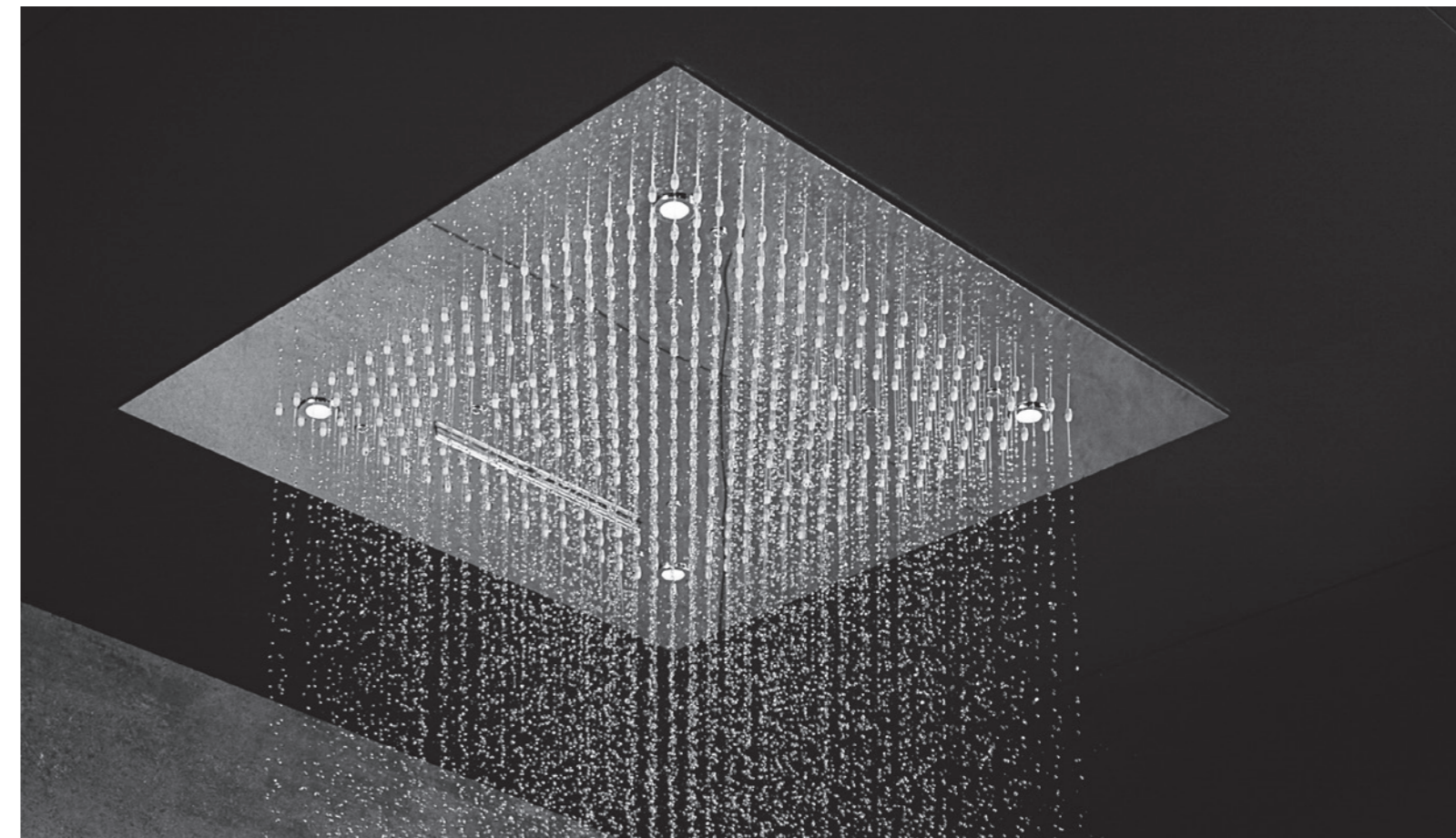
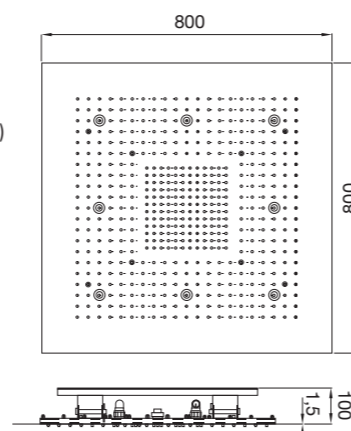

RELAX RAIN REGENPANEEL

für Deckeneinbau, mit Easy Clean

RELAX RAIN SHOWER PANEL

ceiling mounted, with Easy Clean

RELAX RAIN CIEL DE PLUIE

pour montage encastré, avec système anticalcaire „Easy Clean“

DESZCZOWNICA RELAX RAIN

do zabudowy sufitowej, z systemem Easy Clean

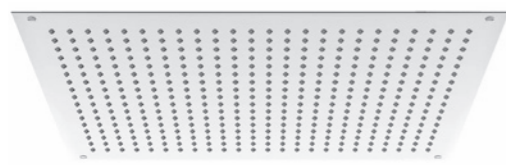

390 6712

750 mm x 550 mm

Edelstahl poliert
polished stainless steel
inox polis
stal szlachetna polerowana



9,5

l/min – 3 bar

390 6713

750 mm x 550 mm

Edelstahl gebürstet
brushed stainless steel
mais inox brossé
szcztokowana stal szlachetna

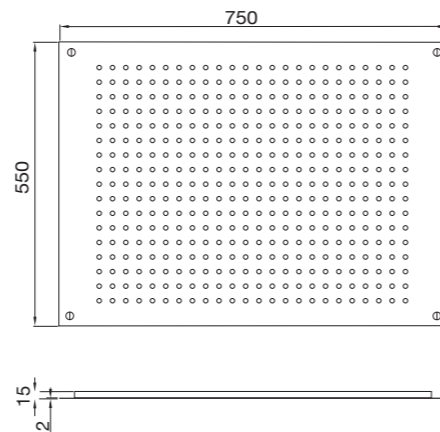

390 6412

450 mm x 450 mm

Edelstahl poliert
polished stainless steel
inox polis
stal szlachetna polerowana



11,2

l/min – 3 bar

390 6413

450 mm x 450 mm

Edelstahl gebürstet
brushed stainless steel
mais inox brossé
szcztokowana stal szlachetna

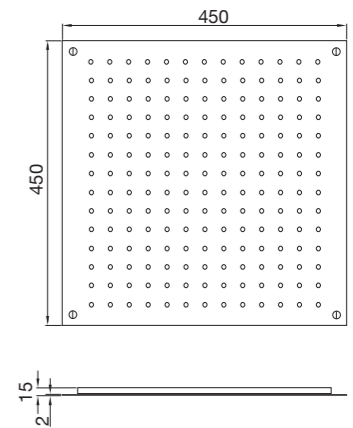

390 6512

550 mm x 550 mm

Edelstahl poliert
polished stainless steel
inox polis
stal szlachetna polerowana



10

l/min – 3 bar

390 6513

550 mm x 550 mm

Edelstahl gebürstet
brushed stainless steel
mais inox brossé
szcztokowana stal szlachetna

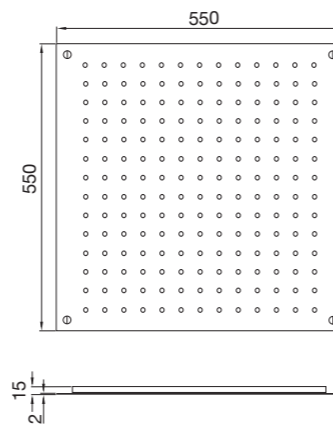

390 6312

350 mm x 350 mm

Edelstahl poliert
polished stainless steel
inox polis
stal szlachetna polerowana



10

l/min – 3 bar

390 6313

350 mm x 350 mm

Edelstahl gebürstet
brushed stainless steel
mais inox brossé
szcztokowana stal szlachetna

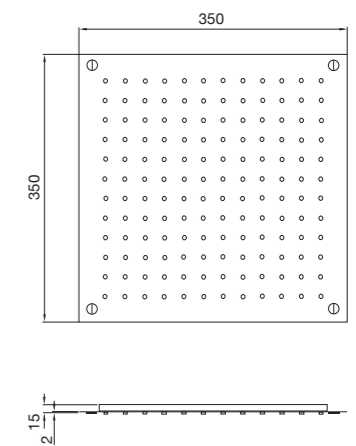

RELAX RAIN REGENPANEEL

für Deckeneinbau, mit Easy Clean

RELAX RAIN SHOWER PANEL

ceiling mounted, with Easy Clean

RELAX RAIN CIEL DE PLUIE

pour montage encastré, avec système anticalcaire „Easy Clean“

DESZCZOWNICA RELAX RAIN

do montażu sufitowego, z systemem Easy Clean

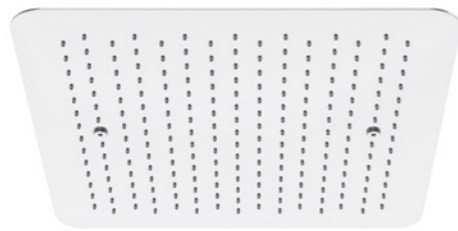

390 5502

500 mm x 500 mm

Edelstahl poliert
polished stainless steel
inox polis
stal szlachetna polerowana

390 5503

500 mm x 500 mm

Edelstahl gebürstet
brushed stainless steel
mais inox brossé
szcztokowana stal szlachetna



11,6

l/min – 3 bar

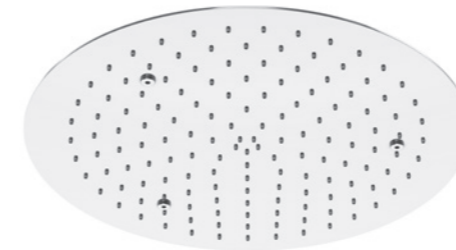
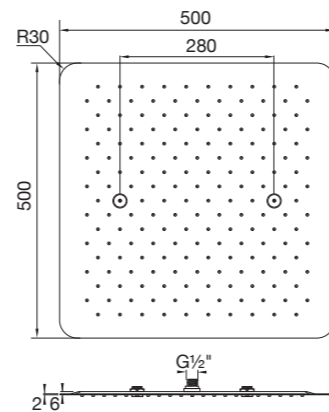

390 5002

ø 500 mm

Edelstahl poliert
polished stainless steel
inox polis
stal szlachetna polerowana



11,6

l/min – 3 bar

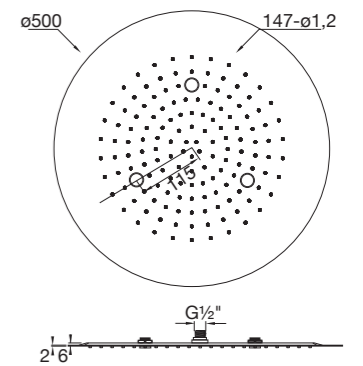

390 4402

400 mm x 400 mm

Edelstahl poliert
polished stainless steel
inox polis
stal szlachetna polerowana

390 4403

400 mm x 400 mm

Edelstahl gebürstet
brushed stainless steel
mais inox brossé
szcztokowana stal szlachetna



13,2

l/min – 3 bar

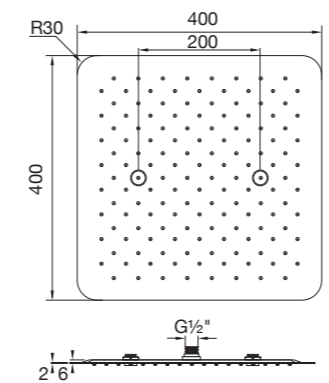

WALL RAIN REGENPANEEL

mit direktem Wandanschluss (½" Außengewinde), mit Easy Clean

WALL RAIN SHOWER PANEL

with direct wall connection (½" male thread), with Easy Clean

WALL RAIN CIEL DE PLUIE

avec raccord pour branchement mural (raccord ½" mâle), avec système anticalcaire „Easy Clean“

DESZCZOWNICA WALL RAIN

z bezpośrednim podłączeniem do ściany (gwint zew. ½"), z systemem Easy Clean



390 5642

628 mm x 280 mm x 143 mm

2 Strahlarten, Edelstahl poliert/weiß

2 functions, polished stainless steel/white

2 fonctions, inox polis/blanc

2 typy strumienia, stal szlachetna polerowana/
biała

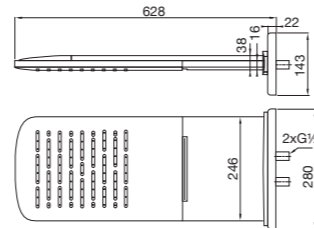

17,2 18,6

l/min – 3 bar

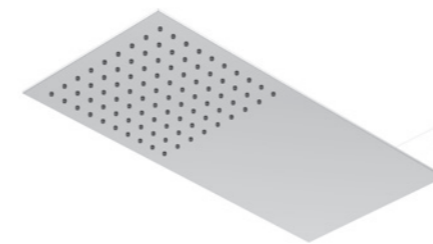

390 1620

430 mm x 200 mm x 60 mm

Regenbrause ultraflach 2 mm,

Edelstahl poliert

Rain shower ultra slim 2 mm,
polished stainless steel

Douche de tête «ultra-mince» 2 mm,
inox polis, (optique chromé)

ultrapłaska 2 mm,
Stal szlachetna polerowana

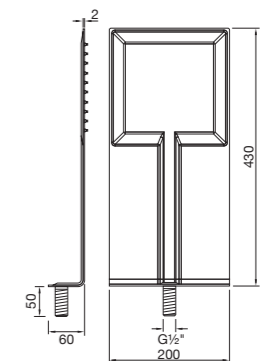

12,5

l/min – 3 bar

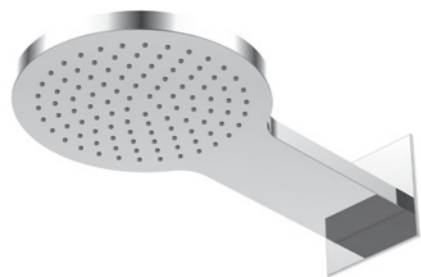

390 5551

550 mm, 300mm, 150 mm

inklusive Einbaukörper, Edelstahl poliert

inclusive installation unit, polished stainless steel
avec système, inox polis

el. montażowy w zestawie, stal szlachetna
polerowana

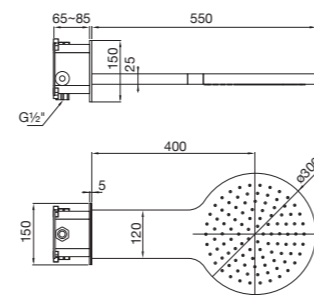

22

l/min – 3 bar

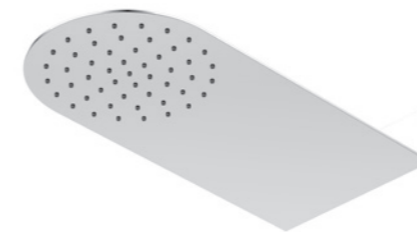

390 1625

430 mm x 200 mm x 60 mm

Regenbrause ultraflach 2 mm,

Edelstahl poliert

Rain shower ultra slim 2 mm,
polished stainless steel

Douche de tête «ultra-mince» 2 mm,
inox polis, (optique chromé)

ultrapłaska 2 mm,
Stal szlachetna polerowana

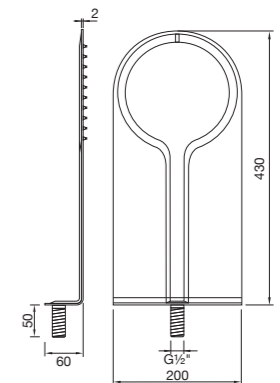

12,5

l/min – 3 bar



WALL RAIN REGENPANEEL

mit direktem Wandanschluss (½" Außengewinde), mit Easy Clean

WALL RAIN SHOWER PANEL

with direct wall connection (½" male thread), with Easy Clean

WALL RAIN CIEL DE PLUIE

avec raccord pour branchement mural (raccord ½" mâle), avec système anticalcaire „Easy Clean“

DESZCZOWNICA WALL RAIN

z bezpośrednim podłączeniem do ściany (gwint zew. ½"), z systemem Easy Clean

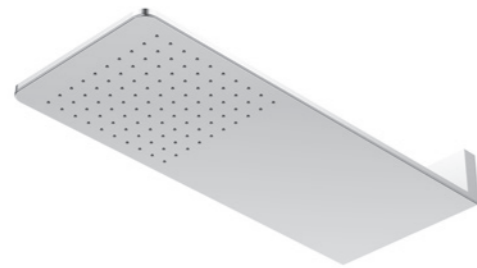

390 5661

600 mm x 250 mm
Edelstahl poliert
polished stainless steel
inox polis
stal szlachetna polerowana

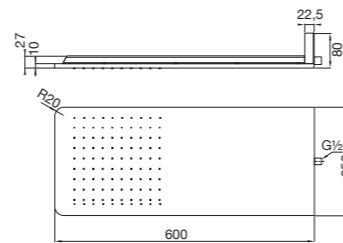

18,1

l/min – 3 bar

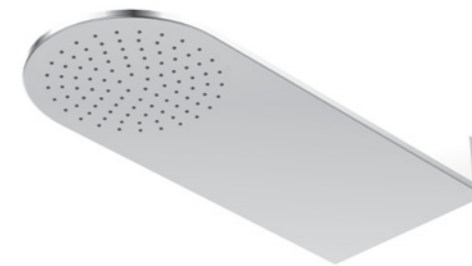

390 5651

600 mm x 250 mm
Edelstahl poliert
polished stainless steel
inox polis
stal szlachetna polerowana

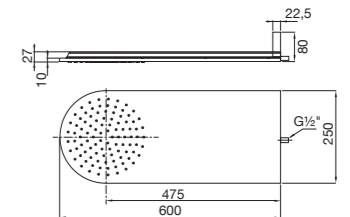

17,1

l/min – 3 bar

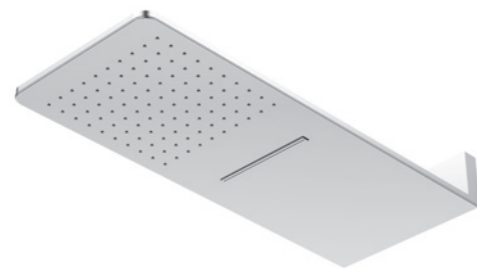

390 5662

600 mm x 250 mm
2 Strahlarten, Edelstahl poliert
2 functi ons, polished stainless steel
2 foncti ons, inox polis
2 typy strumienia, stal szlachetna
polerowana

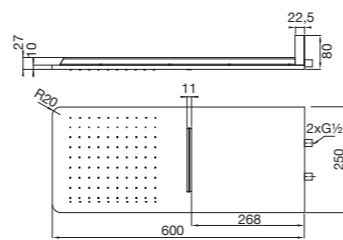

18,5

17,5

l/min – 3 bar

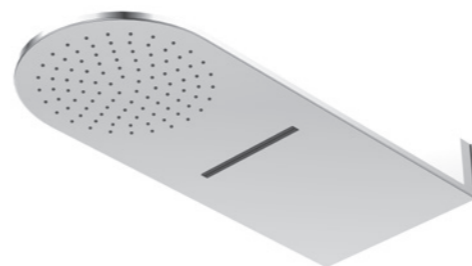

390 5652

600 mm x 250 mm
2 Strahlarten, Edelstahl poliert
2 functi ons, polished stainless steel
2 foncti ons, inox polis
2 typy strumienia, stal szlachetna
polerowana

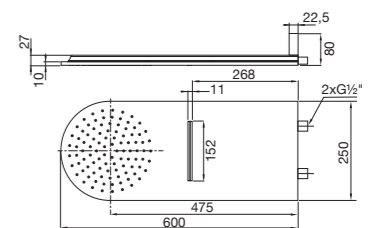

18,5

17,5

l/min – 3 bar



WALL RAIN KOPFBRAUSESET

inklusive Brausearm Wandmontage, mit Easy Clean, chrom

WALL RAIN OVERHEAD SHOWER SET

including wall mounted shower arm, with Easy Clean, chrome

RELAX CIEL DE PLUIE

avec bras de douche intégrée, avec système anticalcaire „Easy Clean“, chromé

ZESTAWY NATRYSKOWE Z DESZCZOWNICĄ RELAX RAIN

wraz z uchwytem do montażu ściennego, z systemem Easy Clean, chrom

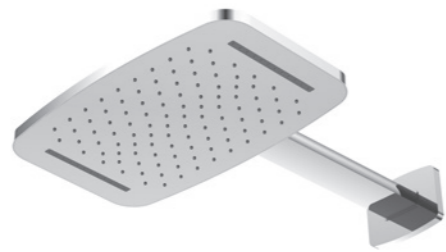

390 7722

570 mm x 405 mm x 94 mm

2 Strahlarten

2 functi ons

2 foncti ons

2 rodzaje strumienia do wyboru



12,9 13,9

l/min – 3 bar

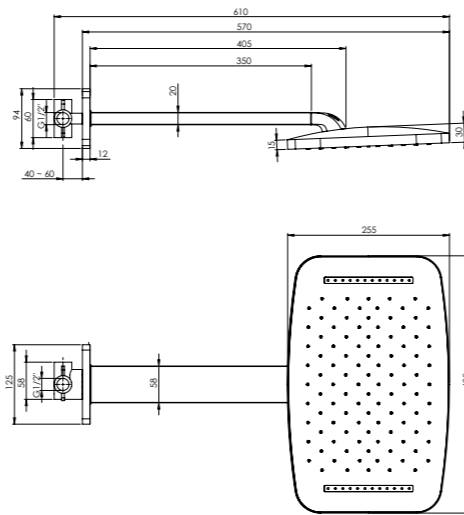

RELAX RAIN KOPFBRAUSESET

inklusive Brausearm Deckenmontage, mit Easy Clean, chrom

RELAX RAIN OVERHEAD SHOWER SET

including ceiling mounted shower arm, with Easy Clean, chrome

RELAX CIEL DE PLUIE

avec bras de douche pour plafond intégrée, avec système anticalcaire „Easy Clean“, chromé

DESZCZOWNICA RELAX RAIN

w komplecie ramię deszczownicy montowane do sufitu, z systemem Easy-clean, chrom



390 7721 ^{new}

290 mm x 310 mm x 90 mm,

2 Strahlarten

2 functi ons

2 foncti ons

2 rodzaje strumienia do wyboru



8,5 18

l/min – 3 bar

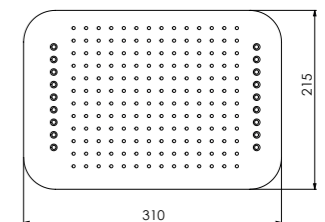
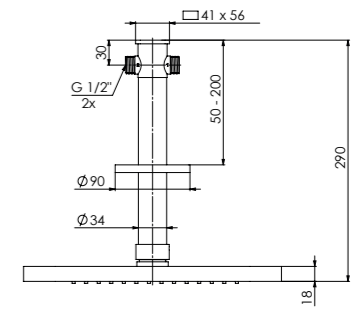

390 7723 ^{new}

551 mm x 300 mm x 142 mm

3 Strahlarten

3 functi ons

3 foncti ons

3 rodzaje strumienia do wyboru



17,5 8,5 19,4

l/min – 3 bar

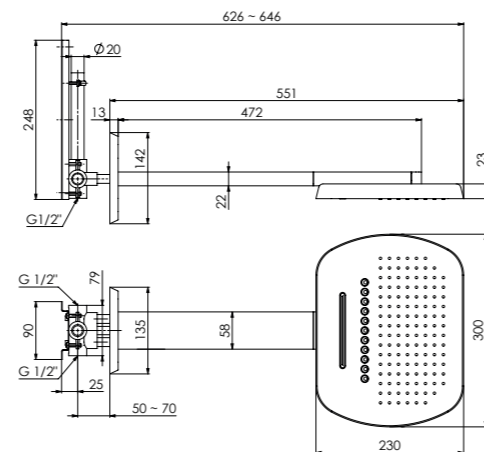

REGENBRAUSE

mit Easy Clean

RAIN SHOWER

with Easy Clean

DOUCHE DE TÊTE

avec système anticalcaire „Easy Clean“

DESZCZOWNICA

z systemem Easy Clean



100 1687

ø 200 mm x 8 mm, chrom

ø 200 mm x 8 mm, chrome

ø 200 mm x 8 mm, chromé

ø 200 mm x 8 mm, chrom

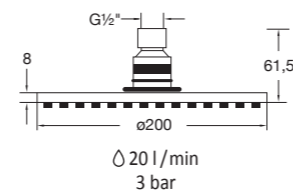

100 1686

ø 250 mm x 8 mm

nur in Verbindung mit Brausearm 100 7910
oder Deckenmontage, chrom

only with 100 7910 or ceiling mounted, chrome

à uti liser avec bras de plafond ou bras

mural 100 7910, chromé

tylko z ramieniem 100 7910 lub montaż sufi towy,
chrom

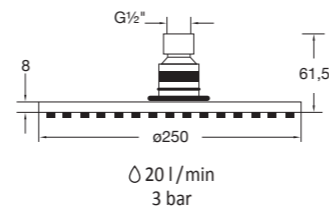

new ● Matt Black 100 1686 S

● Brushed Nickel 100 1686 BN

100 1688

ø 300 mm x 8 mm

nur in Verbindung mit Brausearm 100 7910
oder Deckenmontage, chrom

only with 100 7910 or ceiling mounted, chrome

à uti liser avec bras de plafond ou bras

mural 100 7910, chromé

tylko z ramieniem 100 7910 lub montaż sufi towy,
chrom

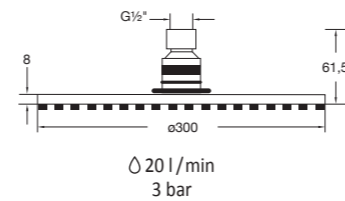

new ● Matt Black 100 1688 S

100 1689

ø 400 mm x 8 mm

nur in Verbindung mit Brausearm 100 7910
oder Deckenmontage, chrom

only with 100 7910 or ceiling mounted, chrome

à uti liser avec bras de plafond ou bras

mural 100 7910, chromé

tylko z ramieniem 100 7910 lub montaż sufi towy,
chrom

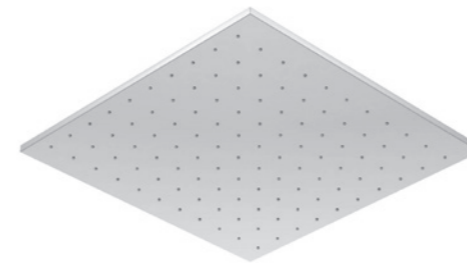
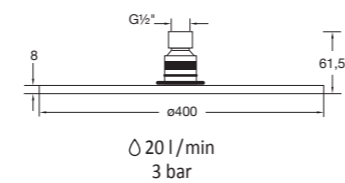

120 1687

145 mm x 220 mm x 9,5 mm, chrom

145 mm x 220 mm x 9,5 mm, chrome

145 mm x 220 mm x 9,5 mm, chromé

145 mm x 220 mm x 9,5 mm, chrom

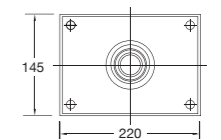
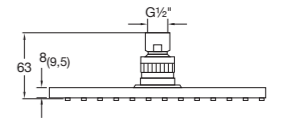

ø 18 l/min
3 bar

120 1688

200 mm x 300 mm x 8 mm

nur in Verbindung mit Brausearm 120 7910
oder Deckenmontage, chrom

only with 120 7910 or ceiling mounted, chrome

à uti liser avec bras de plafond ou bras

mural 120 7910, chromé

tylko z ramieniem 120 7910 lub montaż sufi towy,
chrom

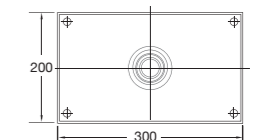

ø 18 l/min
3 bar

120 1686

300 mm x 300 mm x 8 mm

nur in Verbindung mit Brausearm 120 7910
oder Deckenmontage, chrom

only with 120 7910 or ceiling mounted, chrome

à uti liser avec bras de plafond ou bras

mural 120 7910, chromé

tylko z ramieniem 120 7910 lub montaż sufi towy,
chrom

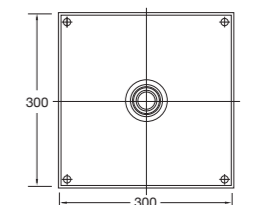

ø 18 l/min
3 bar

new ● Matt Black 120 1686 S

120 1689

400 mm x 400 mm x 8 mm

nur in Verbindung mit Brausearm 120 7910
oder Deckenmontage, chrom

only with 120 7910 or ceiling mounted, chrome

à uti liser avec bras de plafond ou bras

mural 120 7910, chromé

tylko z ramieniem 120 7910 lub montaż sufi towy,
chrom

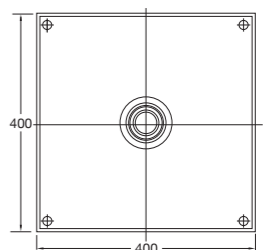

ø 18 l/min
3 bar



100 7900 |
100 7910 |



100 1571 |
100 1581 |
100 1591 |

276 SEITE
PAGE



120 7900 |
120 7910 |



120 1571 |
120 1581 |
120 1591 |

276 SEITE
PAGE

REGENBRAUSE ULTRAFLACH

mit Easy Clean, chrom

RAIN SHOWER ULTRA FLAT

with Easy Clean, chrome

DOUCHE DE TÊTE ULTRA-MINCE

avec système anticalcaire „Easy Clean“, chromé

DESZCZOWNICA ULTRAPŁASKA

z systemem Easy Clean, chrom

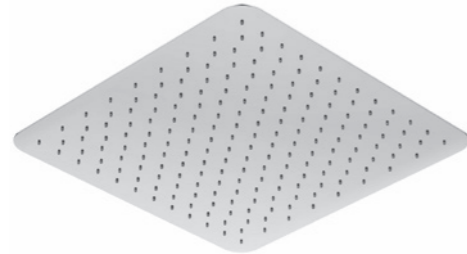

390 1680

200 x 200 x 2 mm



390 1681

250 x 250 x 2 mm

nur in Verbindung mit Brausearm 100 7910
oder Deckenmontage

only with shower arm 100 7910 or ceiling mounted
à uti liser avec bras de plafond ou bras
mural 100 7910

tylko z ramieniem 100 7910 lub montaż sufi towy

390 1682

300 x 300 x 2 mm

nur in Verbindung mit Brausearm 100 7910
oder Deckenmontage

only with shower arm 100 7910 or ceiling mounted
à uti liser avec bras de plafond ou bras
mural 100 7910

tylko z ramieniem 100 7910 lub montaż sufi towy

390 1683

400 x 400 x 2 mm

nur in Verbindung mit Brausearm 100 7910
oder Deckenmontage

only with shower arm 100 7910 or ceiling mounted
à uti liser avec bras de plafond ou bras
mural 100 7910

tylko z ramieniem 100 7910 lub montaż sufi towy

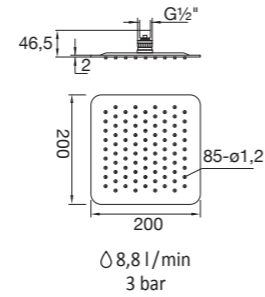

Ø 8,8 l/min
3 bar

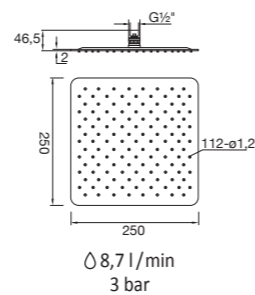

Ø 8,7 l/min
3 bar

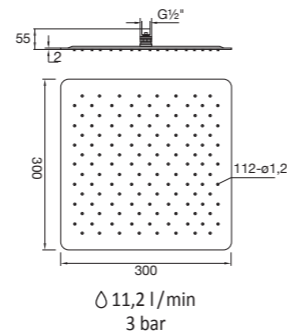

Ø 11,2 l/min
3 bar

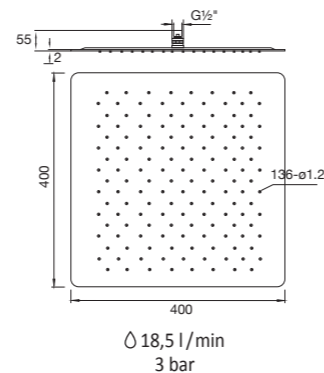

Ø 18,5 l/min
3 bar

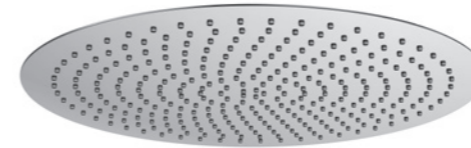

390 1686

ø 200 mm x 2 mm



390 1687

ø 250 mm x 2 mm

nur in Verbindung mit Brausearm 100 7910
oder Deckenmontage

only with shower arm 100 7910 or ceiling mounted
à uti liser avec bras de plafond ou bras
mural 100 7910

tylko z ramieniem 100 7910 lub montaż sufi towy

390 1688

ø 300 mm x 2 mm

nur in Verbindung mit Brausearm 100 7910
oder Deckenmontage

only with shower arm 100 7910 or ceiling mounted
à uti liser avec bras de plafond ou bras
mural 100 7910

tylko z ramieniem 100 7910 lub montaż sufi towy

390 1689

ø 400 mm x 2 mm

nur in Verbindung mit Brausearm 100 7910
oder Deckenmontage

only with shower arm 100 7910 or ceiling mounted
à uti liser avec bras de plafond ou bras
mural 100 7910

tylko z ramieniem 100 7910 lub montaż sufi towy

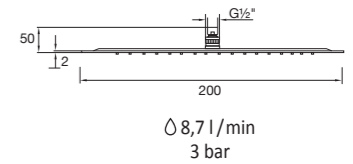

Ø 8,7 l/min
3 bar

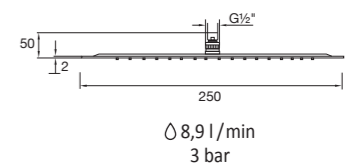

Ø 8,9 l/min
3 bar

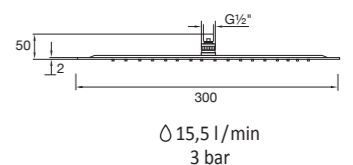

Ø 15,5 l/min
3 bar

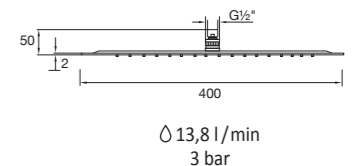

Ø 13,8 l/min
3 bar



100 7900 |
100 7910 |



100 1571 |
100 1581 |
100 1591 |

276 SEITE
PAGE



100 7900 |
100 7910 |



100 1571 |
100 1581 |
100 1591 |

276 SEITE
PAGE